

Rotarix™ (Oral suspension)

1. NAME OF THE MEDICINAL PRODUCT

Rotarix™
Rotarix™ (Oral suspension)
Rotavirus vaccine

2. QUALITATIVE AND QUANTITATIVE COMPOSITION

1 dose (1.5 ml) contains:
Live attenuated human rotavirus RIX4414 strain not less than $10^{6.0}$ CCID₅₀

3. PHARMACEUTICAL FORM

Oral suspension.
The vaccine is a clear and colourless liquid.

4. CLINICAL PARTICULARS

4.1 Therapeutic Indications

Rotarix™ is indicated for the prevention of gastro-enteritis caused by rotavirus (see sections 4.4 Special Warnings and Precautions for Use and 5.1 Pharmacodynamic Properties).

4.2 Posology and Method of Administration

Posology

The vaccination course consists of two doses. The first dose may be administered from the age of 6 weeks. There should be an interval of at least 4 weeks between doses. The vaccination course should be completed by the age of 24 weeks.

Rotarix™ may be given to preterm infants with the same posology (see section 4.8 Undesirable Effects and 5.1 Pharmacodynamic Properties).

In clinical trials, spitting or regurgitation of the vaccine has rarely been observed and, under such circumstances, a replacement dose was not given. However, in the unlikely event that an infant spits out or regurgitates most of the vaccine dose, a single replacement dose may be given at the same vaccination visit.

It is strongly recommended that infants who receive a first dose of **Rotarix™** complete the 2-dose regimen with **Rotarix™**.

Method of administration

Rotarix™ is for **oral** use only.

ROTARIX™ SHOULD UNDER NO CIRCUMSTANCES BE INJECTED.

There are no restrictions on the infant's consumption of food or liquid, including breast-milk, either before or after vaccination.

Based on evidence generated in clinical trials, breast-feeding does not reduce the protection against rotavirus gastro-enteritis afforded by **Rotarix™**. Therefore, breast-feeding may be continued during the vaccination schedule.

For information on instructions for administration see section 6.6 Instructions for Use and Handling.

4.3 Contra-indications

RotarixTM should not be administered to subjects with known hypersensitivity after previous administration of **Rotarix**TM vaccine or to any component of the vaccine (see sections 2. Qualitative and Quantitative Composition and 6.1 List of Excipients).

Subjects with history of intussusception.

Subjects with uncorrected congenital malformation (such as Meckel's diverticulum) of the gastrointestinal tract that would predispose to intussusception.

Subjects with Severe Combined Immunodeficiency (SCID) disorder (see section 4.8 Undesirable Effects).

4.4 Special Warnings and Precautions for Use

It is good clinical practice that vaccination should be preceded by a review of the medical history (especially with regard to previous vaccination and possible occurrence of undesirable events) and a clinical examination.

As with other vaccines, administration of **Rotarix**TM should be postponed in subjects suffering from acute severe febrile illness. However, the presence of a minor infection, such as a cold, should not result in the deferral of vaccination.

The administration of **Rotarix**TM should be postponed in subjects suffering from diarrhoea or vomiting.

There are no data on the safety and efficacy of **Rotarix**TM in infants with gastrointestinal illnesses. Administration of **Rotarix**TM may be considered with caution in such infants when, in the opinion of the physician, withholding the vaccine entails a greater risk.

The risk of intussusception has been evaluated in a large safety trial (including 63,225 infants) conducted in Latin America and Finland. No increased risk of intussusception was observed in this clinical trial following administration of **Rotarix**TM when compared with placebo.

However, post-marketing safety studies indicate a transient increased incidence of intussusception after vaccination, mostly within 7 days of the first dose and, to a lesser extent, the second dose. The overall incidence of intussusception remains rare. Whether **Rotarix**TM affects the overall risk of intussusception has not been established.

As a precaution, healthcare professionals should follow-up on any symptoms indicative of intussusception (severe abdominal pain, persistent vomiting, bloody stools, abdominal bloating and/or high fever). Parents/guardians should be advised to promptly report such symptoms.

For subjects with a predisposition for intussusception, see section 4.3 Contra-indications.

Administration of **Rotarix**TM in immunosuppressed infants, including infants on immunosuppressive therapy, should be based on careful consideration of potential benefits and risks (see section 5.1 Pharmacodynamic Properties).

Excretion of the vaccine virus in the stools is known to occur after vaccination and lasts for 10 days on average with peak excretion around the 7th day (see section 5.1 Pharmacodynamic Properties). In clinical trials, cases of transmission of excreted vaccine virus to seronegative contacts of vaccinees have been observed without causing any clinical symptoms. **Rotarix**TM should be administered with caution to individuals with immunodeficient close contacts, such as individuals with malignancies, or who are otherwise immunocompromised or receiving

immunosuppressive therapy. Contacts of recent vaccinees should be advised to observe careful hygiene (including washing their hands) when changing children's nappies.

As with any vaccine, a protective immune response may not be elicited in all vaccinees (see section 5.1 Pharmacodynamic Properties).

The extent of protection that **Rotarix**TM might provide against rotavirus strains that have not been circulating in clinical trials is currently unknown (see section 5.1 Pharmacodynamic Properties).

RotarixTM does not protect against gastro-enteritis due to other pathogens than rotavirus.

ROTARIXTM SHOULD UNDER NO CIRCUMSTANCES BE INJECTED.

4.5 Interaction With Other Medicinal Products and Other Forms of Interaction

RotarixTM can be given concomitantly with any of the following monovalent or combination vaccines [including hexavalent vaccines (DTPa-HBV-IPV/Hib)]: diphtheria-tetanus-whole cell pertussis vaccine (DTPw), diphtheria-tetanus-acellular pertussis vaccine (DTPa), *Haemophilus influenzae* type b vaccine (Hib), inactivated polio vaccine (IPV), hepatitis B vaccine (HBV), pneumococcal conjugate vaccine and meningococcal serogroup C conjugate vaccine. Clinical studies demonstrated that the immune responses to and the safety profiles of the administered vaccines were unaffected.

Concomitant administration of **Rotarix**TM and oral polio vaccine (OPV) does not affect the immune response to the polio antigens. Although concomitant administration of OPV may slightly reduce the immune response to rotavirus vaccine, clinical protection against severe rotavirus gastro-enteritis was shown to be maintained.

4.6 Pregnancy and Lactation

RotarixTM is not intended for use in adults. Thus human data on use during pregnancy or lactation are not available and animal reproduction studies have not been performed.

4.7 Effects on Ability to Drive and Use Machines

RotarixTM is not intended for use in adults.

4.8 Undesirable Effects

Clinical trial data

The following convention has been used for the classification of frequency:

Very common	≥ 1/10
Common	≥ 1/100 and < 1/10
Uncommon	≥ 1/1,000 and < 1/100
Rare	≥ 1/10,000 and < 1/1,000
Very rare	< 1/10,000

The safety profile presented below is based on data from clinical trials conducted with either the lyophilised or the liquid formulation of **Rotarix**TM.

In a total of four clinical trials, approximately 3,800 doses of **Rotarix**TM liquid formulation were administered to approximately 1,900 infants. Those trials have shown that the safety profile of the liquid formulation is comparable to the lyophilised formulation.

In a total of twenty-three clinical trials, approximately 106,000 doses of **Rotarix**TM (lyophilised or liquid formulation) were administered to approximately 51,000 infants.

In three placebo-controlled clinical trials, in which **Rotarix™** was administered alone (administration of routine paediatric vaccines was staggered), the incidence and severity of the solicited events (collected 8 days post-vaccination), diarrhoea, vomiting, loss of appetite, fever, irritability and cough/runny nose, were not significantly different in the group receiving **Rotarix™** when compared to the group receiving placebo. No increase in the incidence or severity of these events was seen with the second dose.

In a pooled analysis from seventeen placebo-controlled clinical trials including trials in which **Rotarix™** was co-administered with routine paediatric vaccines (see section 4.5 Interaction With Other Medicinal Products and Other Forms of Interaction), the following adverse reactions (collected 31 days post-vaccination) were considered as possibly related to vaccination.

Gastrointestinal disorders

Common : diarrhoea

Uncommon : flatulence, abdominal pain

Skin and subcutaneous tissue disorders

Uncommon : dermatitis

General disorders and administration site conditions

Common : irritability

The risk of intussusception has been evaluated in a large safety trial conducted in Latin America and Finland where 63,225 subjects were enrolled. This trial gave evidence of no increased risk of intussusception in the **Rotarix™** group when compared with the placebo group as shown in the table below.

	Rotarix™	Placebo	Relative risk (95% CI)
Intussusception within 31 days after administration of:	N=31,673	N=31,552	
First dose	1	2	0.50 (0.07;3.80)
Second dose	5	5	0.99 (0.31;3.21)
Intussusception up to one year of age	N=10,159	N=10,010	
First dose up to one year of age	4	14	0.28 (0.10;0.81)

CI: confidence interval

Safety in preterm infants

In a clinical study, 1,009 preterm infants were administered **Rotarix™** lyophilised formulation or placebo (198 were 27-30 weeks gestational age and 801 were 31-36 weeks gestational age). The first dose was administered from 6 weeks after birth. Serious adverse events were observed in 5.1% of recipients of **Rotarix™** as compared to 6.8% of placebo recipients. Similar rates of other adverse events were observed in **Rotarix™** and placebo recipients. No cases of intussusception were reported.

Post marketing dataGastrointestinal disorders:

Rare : haematochezia, gastroenteritis with vaccine viral shedding in infants with Severe Combined Immunodeficiency (SCID) disorder.

Very rare : intussusception (see section 4.4 Special Warnings and Precautions for Use).

4.9 Overdose

Some cases of overdose have been reported. In general, the adverse event profile reported in these cases was similar to that observed after administration of the recommended dose of **Rotarix™**.

5. PHARMACOLOGICAL PROPERTIES

Pharmaco-therapeutic group: viral vaccines, ATC code: J07BH01

5.1 Pharmacodynamic PropertiesProtective efficacy

In clinical trials, efficacy was demonstrated against gastro-enteritis due to rotavirus of the most common genotypes G1P[8], G2P[4], G3P[8], G4P[8] and G9P[8] and against uncommon rotavirus genotypes G8P[4] (severe gastro-enteritis) and G12P[6] (any gastro-enteritis). All of these strains are circulating worldwide. Clinical studies have been conducted in Europe, Latin America, Africa and Asia to evaluate the protective efficacy of Rotarix against any and severe rotavirus gastro-enteritis.

Severity of gastro-enteritis was defined according to two different criteria:

- the Vesikari 20-point scale, which evaluates the full clinical picture of rotavirus gastro-enteritis by taking into account the severity and duration of diarrhoea and vomiting, the severity of fever and dehydration as well as the need for treatment

or

-the clinical case definition based on World Health Organization (WHO) criteria

Protective efficacy in Europe and Latin America

After two doses of **Rotarix™**, the protective vaccine efficacy observed in the studies conducted in Europe and Latin America during the first and second year of life combined is presented in table 1 and table 2.

**Table 1: Study conducted in Europe: 1st and 2nd year of life combined
(Rotarix™ N=2,572; Placebo N=1,302 (§))**

Vaccine efficacy (%) against any and severe rotavirus gastro-enteritis (95% CI)		
Strain	Any severity	Severe[†]
G1P[8]	89.5 (82.5;94.1)	96.4 (90.4;99.1)
G2P[4]	58.3 (10.1;81.0)	85.5 (24.0;98.5)
G3P[8]	84.8 (41.0;97.3)	93.7 (52.8;99.9)
G4P[8]	83.1 (55.6;94.5)	95.4 (68.3;99.9)

G9P[8]	72.5 (58.6;82.0)	84.7 (71.0;92.4)
Strains with P[8] genotype	81.8 (75.8; 86.5)	91.9 (86.8;95.3)
Circulating rotavirus strains	78.9 (72.7;83.8)	90.4 (85.1;94.1)
Vaccine efficacy (%) against rotavirus gastro-enteritis requiring medical attention (95% CI)		
Circulating rotavirus strains	83.8 (76.8;88.9)	
Vaccine efficacy (%) against hospitalisation due to rotavirus gastro-enteritis (95% CI)		
Circulating rotavirus strains	96.0 (83.8;99.5)	

† Severe gastro-enteritis was defined as a score ≥ 11 on the Vesikari scale

(§) ATP cohort for efficacy. This includes all subjects from the ATP cohort for safety who have entered into the concerned efficacy follow-up period.

Table 2: Study conducted in Latin America: 1st and 2nd year of life combined (Rotarix™ N=7,205; Placebo N=7,081(§))

Strain	Vaccine efficacy (%) against severe rotavirus gastro-enteritis† (95% CI)	
All RVGE	80.5 (71.3;87.1)	
G1P[8]	82.1 (64.6;91.9)	
G3P[8]	78.9 (24.5;96.1)	
G4P[8]	61.8 (4.1;86.5)	
G9P[8]	86.6 (73.0;94.1)	
Strains with P[8] genotype	82.2 (73.0;88.6)	

† Severe rotavirus gastro-enteritis was defined as an episode of diarrhoea with or without vomiting that required hospitalization and/or re-hydration therapy in a medical facility (WHO criteria)

(§) ATP cohort for efficacy. This includes all subjects from the ATP cohort for safety who have entered into the concerned efficacy follow-up period.

The vaccine efficacy against severe rotavirus gastro-enteritis was 38.6% (95% CI:<0.0;84.2) for G2P[4] strain. The number of cases, on which the estimates of efficacy against G2P[4] were based, were very small.

A pooled analysis of four efficacy studies, showed a 71.4% (95% CI:20.1;91.1) efficacy against severe gastro-enteritis (Vesikari score ≥ 11) caused by rotavirus G2P[4] strain.

Since the immune response observed after 2 doses of **Rotarix™** liquid formulation was comparable to the immune response observed after 2 doses of **Rotarix™** lyophilised

formulation, the levels of vaccine efficacy observed with the lyophilised formulation can be extrapolated to the liquid formulation.

Protective efficacy in Africa

A clinical study performed in Africa in more than 4,900 subjects evaluated **Rotarix™** given at approximately 10 and 14 weeks of age (2 doses) or 6, 10 and 14 weeks of age (3 doses). The vaccine efficacy against severe rotavirus gastro-enteritis during the first year of life was 61.2% (95% CI:44.0;73.2). The study was not powered to evaluate a difference in vaccine efficacy between the 2- and 3-dose regimens.

The protective vaccine efficacy observed against any and severe rotavirus gastro-enteritis is presented in Table 3.

Table 3: Study conducted in Africa: 1st year of life – pooled results
(**Rotarix™ N=2,974; Placebo N = 1,443 (§)**)

Vaccine efficacy (%) against any and severe rotavirus gastro-enteritis		
(95% CI)		
Strain	Any severity	Severe[†]
G1P[8]	68.3 (53.6;78.5)	56.6 (11.8;78.8)
G2P[4]	49.3 (4.6;73.0)	83.8 (9.6;98.4)
G3P[8]	43.4* (<0;83.7)	51.5* (<0;96.5)
G8P[4]	38.7* (<0;67.8)	63.6 (5.9;86.5)
G9P[8]	41.8* (<0;72.3)	56.9* (<0;85.5)
G12P[6]	48.0 (9.7;70.0)	55.5* (<0;82.2)
Strains with P[4] genotype	39.3 (7.7;59.9)	70.9 (37.5;87.0)
Strains with P[6] genotype	46.6 (9.4;68.4)	55.2* (<0;81.3)
Strains with P[8] genotype	61.0 (47.3;71.2)	59.1 (32.8;75.3)

[†] Severe gastro-enteritis was defined as a score ≥ 11 on the Vesikari scale.

(§) ATP cohort for efficacy. This includes all subjects from the ATP cohort for safety who have entered into the concerned efficacy follow-up period.

* Not statistically significant ($p \geq 0.05$). These data should be interpreted with caution.

Sustained efficacy up to 3 years of age in Asia

A clinical study conducted in Asia (Hong Kong, Singapore and Taiwan) in more than 10,000 subjects evaluated **Rotarix™** given according to different schedules (2, 4 months of age; 3, 4 months of age).

After two doses of **Rotarix™**, the protective vaccine efficacy observed up to 3 years of age is presented in table 4.

**Table 4 : Study conducted in Asia: Efficacy up to 2 and 3 years of age
(Rotarix™ N=5,263; Placebo N = 5,256 (§))**

	Efficacy up to 2 years of age	Efficacy up to 3 years of age
Vaccine efficacy (%) against severe rotavirus gastro-enteritis (95% CI)		
Strain	Severe[†]	Severe[†]
G1P[8]	100.0 (80.8;100.0)	100.0 (84.8;100.0)
G2P[4]	100.0* (<0;100.0)	100.0* (<0;100.0)
G3P[8]	94.5 (64.9;99.9)	95.2 (70.4;99.9)
G9P[8]	91.7 (43.8;99.8)	91.7 (43.8;99.8)
Strains with P[8] genotype	95.8 (83.8;99.5)	96.6 (87.0;99.6)
Circulating rotavirus strains	96.1 (85.1;99.5)	96.9 (88.3;99.6)
Vaccine efficacy (%) against rotavirus gastro-enteritis requiring hospitalisation and/or rehydration therapy in a medical facility (95% CI)		
Circulating rotavirus strains	94.2 (82.2;98.8)	95.5 (86.4;99.1)

† Severe gastro-enteritis was defined as a score ≥ 11 on the Vesikari scale.

(§) ATP cohort for efficacy. This includes all subjects from the ATP cohort for safety who have entered into the concerned efficacy follow-up period.

* Not statistically significant ($p \geq 0.05$). These data should be interpreted with caution.

Immune response

In different clinical studies conducted in Europe, Latin America and Asia, 1,957 infants received **Rotarix™** lyophilised formulation and 1,006 infants received a placebo according to different vaccination schedules. The percentage of subjects initially seronegative for rotavirus (IgA antibody titres < 20 U/ml (by ELISA)) with serum anti-rotavirus IgA antibody titers ≥ 20 U/ml one or two months after the second dose of vaccine or placebo ranges from 77.9% to 100% and from 0% to 17.1% respectively.

In three comparative trials, the immune response elicited by **Rotarix™** liquid formulation was comparable to the one elicited by **Rotarix™** lyophilised formulation.

In a clinical study conducted in Africa, the immune response was evaluated in 332 infants who received **Rotarix™** (N=221) or placebo (N=111) according to a 10 and 14 weeks schedule (2 doses) or 6, 10 and 14 weeks schedule (3 doses). The percentage of subjects initially seronegative for rotavirus (IgA antibody titres < 20 U/ml (by ELISA)) with serum anti-rotavirus IgA antibody titers ≥ 20 U/ml one month after the last dose of vaccine or placebo was 58.4% (pooled regimens) and 22.5%, respectively.

Immune response in preterm infants

In a clinical study conducted in preterm infants with the lyophilised formulation, **Rotarix™** was immunogenic; 85.7% of subjects achieved serum anti-rotavirus IgA antibody titers ≥ 20 U/ml (by ELISA) one month after the second dose of vaccine.

Safety in infants with human immunodeficiency (HIV) infection

In a clinical study, 100 infants with HIV infection were administered **Rotarix™** lyophilised formulation or placebo. The safety profile was similar between **Rotarix™** and placebo recipients.

Vaccine shedding

Excretion of the vaccine virus in the stools occurs after vaccination and lasts for 10 days on average with peak excretion around the 7th day. Viral antigen particles detected by ELISA were found in 50% of stools after the first dose and 4% of stools after the second dose. When these stools were tested for the presence of live vaccine strain, 17% were positive.

In two comparative controlled trials, vaccine shedding after vaccination with **Rotarix™** liquid formulation was comparable to that observed after vaccination with **Rotarix™** lyophilised formulation.

Effectiveness

In observational studies, vaccine effectiveness was demonstrated against severe gastro-enteritis leading to hospitalisation due to rotavirus of common genotypes G1P[8], G2P[4], G3P[8] and G9P[8] as well as the less common rotavirus genotype G9P[4] and G9P[6]. All of these strains are circulating worldwide.

Table 5 shows the results of several matched case-control studies conducted to evaluate the effectiveness of **Rotarix™** against severe rotavirus gastro-enteritis leading to hospitalisation.

Table 5 : Effectiveness against severe rotavirus gastro-enteritis leading to hospitalisation

Countries	Age	N (cases/ controls)	Effectiveness after 2 doses RV hospitalization	
			Strain	Effectiveness (%) (95% CI)
High Income Countries				
Belgium	< 4 yrs	160/198	All	90 (81;95)
	3-11 m		G1P[8]	95 (78;99)
			G2P[4]	85 (64;94)
Singapore	< 5 yrs	136/272	All	91 (75;97)
			G2P[4]	83 (11;96)
Taiwan	< 3 yrs	275/1,623	All	84 (32;96)
US	< 2 yrs	85/1,062	G1P[8]	91 (30;99)
	8-11 m		All	92 (75;98)
			G1P[8]	95 (69;100)
US	< 5 yrs	74/255	All	85 (73;92)
			G1P[8]	88 (68;95)
			G2P[4]	88 (68;95)
			All	89 (48;98)
			G3P[8]	68 (34;85)
Middle Income Countries				
Bolivia	< 3 yrs	300/974	All	77 (65;84)
			G9P[8]	85 (69;93)

			G3P[8]	93 (70;98)
			G2P[4]	69 (14;89)
			G9P[6]	87 (19;98)
	6-11 m		All	77 (51;89)
			G9P[8]	90 (65;97)
Brazil	< 2 yrs	115/1,481	All	72 (44;85)
			G1P[8]	89 (78;95)
			G2P[4]	76 (64;84)
Brazil	< 3 yrs	249/249	All	76 (58;86)
			G2P[4]	75 (57;86)
	3-11 m		All	96 (68;99)
			G2P[4]	95 (66;99)
El Salvador	< 2 yrs	251/770	All	76 (64;84)*
	6-11 m			83 (68;91)
Mexico	< 2 yrs	9/17	G9P[4]	94 (16;100)
Low Income Countries				
Malawi	< 2 yrs	81/234	All	63 (23;83)

* In subjects who did not receive the full course of vaccination, the effectiveness after one dose was 51% (95% CI:26;67).

yr(s): year(s)

m: months

Impact on mortality[§]

Impact studies with **Rotarix™** conducted in Panama, Brazil and Mexico showed a decrease in all cause diarrhoea mortality ranging from 22% to 56% in children less than 5 years of age, within 2 to 3 years after vaccine introduction.

Impact on hospitalisation[§]

In a retrospective database study in Belgium conducted in children 5 years of age and younger, the direct and indirect impact of **Rotarix™** vaccination on rotavirus-related hospitalisation ranged from 64% (95% CI:49;76) to 80% (95% CI:77;83) two years after vaccine introduction. Similar studies in Brazil, Australia and El Salvador showed a reduction of 45 to 88%. In addition, two impact studies on all-cause diarrhoea hospitalisation conducted in Latin America showed a reduction of 38 to 40% four years after vaccine introduction.

[§]NOTE : Impact studies are meant to establish a temporal relationship but not a causal relationship between the disease and vaccination.

5.2 Pharmacokinetic Properties

Evaluation of pharmacokinetic properties is not required for vaccines.

5.3 Clinical Studies

See section 5.1 Pharmacodynamic Properties

5.4 Preclinical Safety Data

Preclinical data reveal no special hazard for humans based on conventional studies of repeated dose toxicity.

6. PHARMACEUTICAL PARTICULARS

6.1 List of Excipients

Sucrose, di-sodium adipate, Dulbecco's Modified Eagle Medium (DMEM), sterile water.

Porcine Circovirus type 1 (PCV-1) material has been detected in **Rotarix**TM vaccine. PCV-1 is not known to cause disease in animals and is not known to infect or cause disease in humans. There is no evidence that the presence of PCV-1 poses a safety risk.

6.2 Incompatibilities

This medicinal product must not be mixed with other medicinal products.

6.3 Shelf-life

The expiry date of the vaccine is indicated on the label and packaging.

6.4 Special Precautions for Storage

Store in a refrigerator (2°C-8°C). Do not freeze.

Store in the original package in order to protect from light.

6.5 Nature and Contents of Container

RotarixTM in squeezable tube

1.5 ml of **oral** suspension in a squeezable tube (LDPE) fitted with a membrane and a cap (polypropylene).

Pack sizes of 1, 10 or 50.

RotarixTM in oral applicator

1.5 ml of **oral** suspension in an **oral** applicator (Type I, Ph.Eur.) with a plunger stopper (butyl rubber).

Pack sizes of 1, 5, 10, 25, 50 or 100.

6.6 Instructions for Use and Handling (see end of the leaflet)

The vaccine is presented as a clear, colourless liquid, free of visible particles, for **oral** administration.

The vaccine is ready to use (no reconstitution or dilution is required).

The vaccine is to be administered **orally** without mixing with any other vaccines or solutions.

The vaccine should be inspected visually for any foreign particulate matter and/or abnormal physical appearance. In the event of either being observed, discard the vaccine.

Any unused vaccine or waste material should be disposed of in accordance with local requirements.

Instructions for administration of the vaccine in squeezable tube

Please read the instructions for use all the way through before starting to give the vaccine.

A What you need to do before giving Rotarix™

- Check the expiry date.
- Check the tube has not been damaged nor is already open.
- Check the liquid is clear and colourless, without any particles in it.

If you notice anything abnormal, do not use the vaccine.

- This vaccine is given orally - straight from the tube.
- It is ready to use - you do not need to mix it with anything.

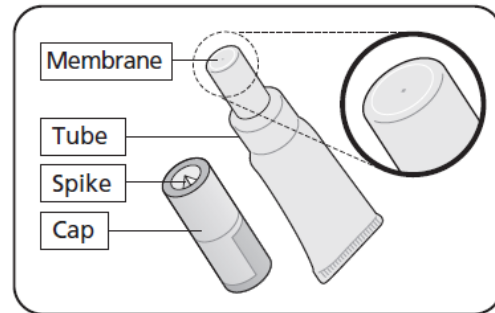

B Get the tube ready

1. Pull off the cap

- Keep the cap – you need this to pierce the membrane.
- Hold the tube upright.

2. Repeatedly flick the top of the tube until it is clear of any liquid

- Clear any liquid from the thinnest section of the tube by flicking just below the membrane.

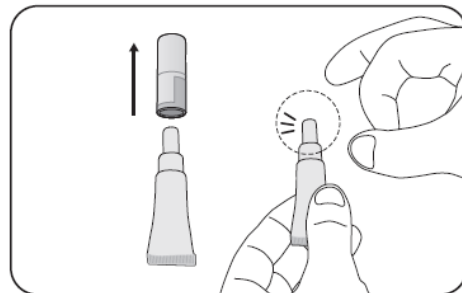

3. Position the cap to open the tube

- Keep the tube held upright.
- Hold the side of tube
- There is a small spike inside the top of the cap - in the centre.
- Turn the cap upside down (180°).

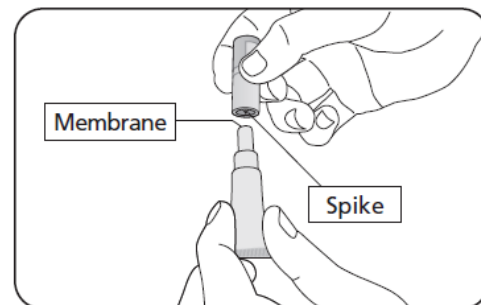

4. To open the tube

- You do not need to twist. Press the cap down to pierce the membrane.
- Then lift off the cap.

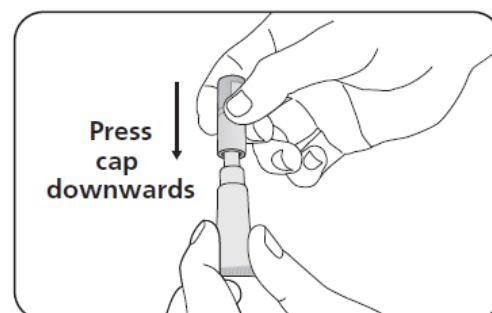

C Check the tube has opened correctly**1. Check the membrane has been pierced**

- There should be a hole at the top of the tube.

2. What to do if the membrane has not been pierced

- If the membrane has not been pierced return to section B and repeat steps 2, 3 and 4.

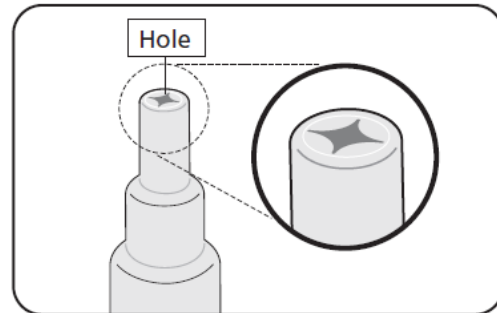
**D Give the vaccine**

- Once the tube is open check the liquid is clear, without any particles in it.
If you notice anything abnormal, do not use the vaccine.
- Give the vaccine straight away.

1. Position the child to give the vaccine

- Seat the child leaning slightly backwards.

2. Administer the vaccine

- Squeeze the liquid gently into the side of the child's mouth - towards the inside of their cheek.
- You may need to squeeze the tube a few times to get all of the vaccine out - it is okay if a drop remains in the tip of the tube.

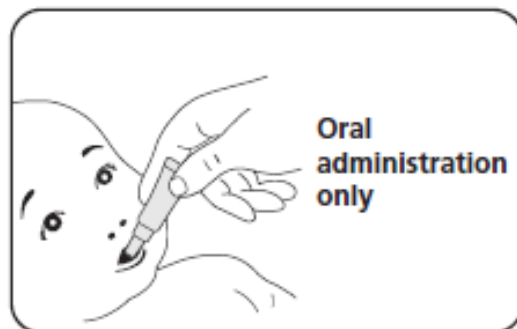
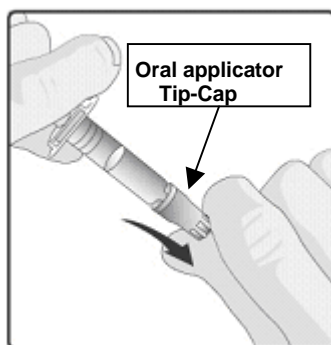
**Instructions for administration of the vaccine in oral applicator**

1. Remove the protective tip cap from the oral applicator.



2. This vaccine is for oral administration only. The child should be seated in a reclining position. Administer orally (i.e. into the child's mouth towards the inner cheek) the entire content of the oral applicator.

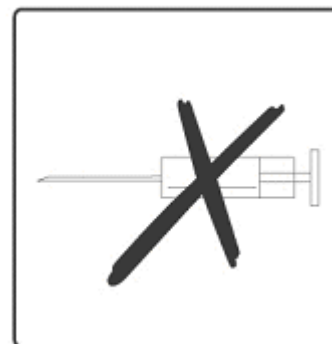

3. **Do not inject.**

Not all presentations are available in every country.

7. MARKETING AUTHORISATION HOLDER

GlaxoSmithKline (Thailand) Ltd.

8. MARKETING AUTHORISATION NUMBER

1C 10/52 (NB)

9. DATE OF FIRST AUTHORISATION

26 June 2009 (Unconditional License)

Rotarix is a trademark of the GSK group of companies.

Version number: GDS014/IPI011 / Date of issue: 05/07/2016

©2016 GSK group of companies

Manufacturer:

GlaxoSmithKline Biologicals s.a.
89, rue de l'Institut - 1330 Rixensart
Belgium

Tel: (32) 2 656 81 11 Fax: (32) 2 656 80 00

ROTARIX SUSP 11.0 TH

